

Article number: 201055299

Description: E+G Handwheel
GN 949-125-B12-A

Measures

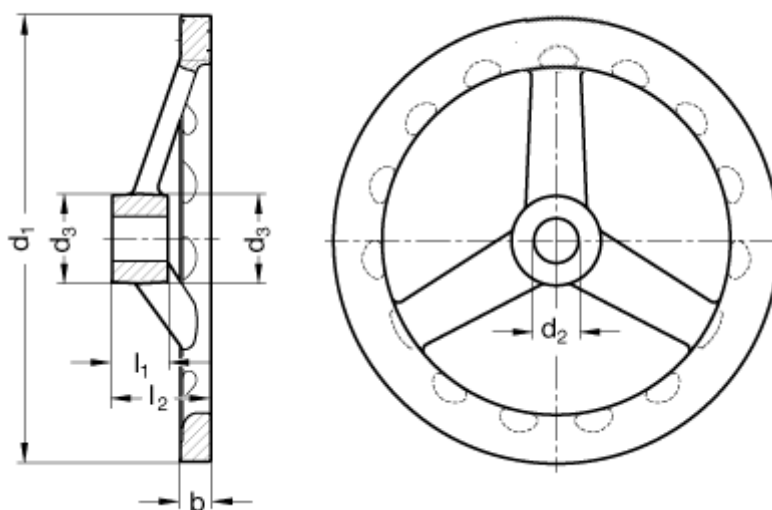

A/F = 9

b = 9

d1 = 125

d2 = 12

d3 = 24

l1 = 16

l2 = 28,5

l3 = 55

Number of spokes = 3